

Mehrzweckventilgehäuse NG 6 mit Lochbild nach DIN 24340, Form A - Zwischenplattenbauweise

MGZ-06.-..

Gewicht: ca. 0.5 kg (A)
ca. 1.0 kg (S)

Nenndruck: 250 bar (A)
350 bar (S)

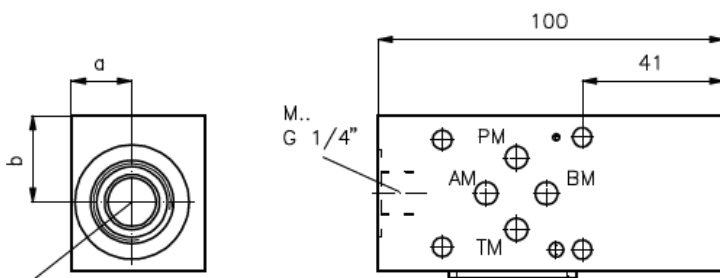
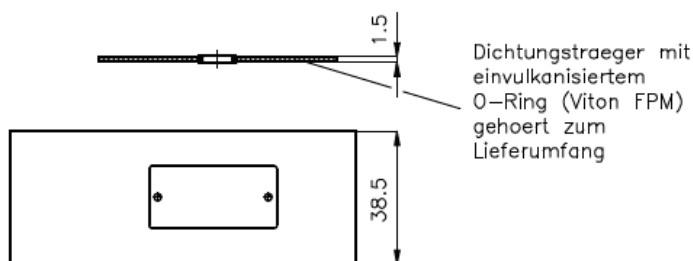
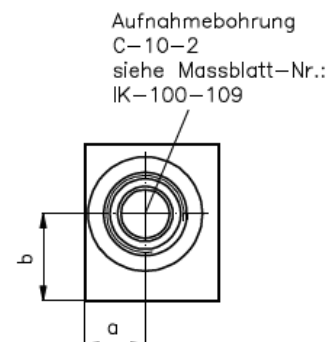
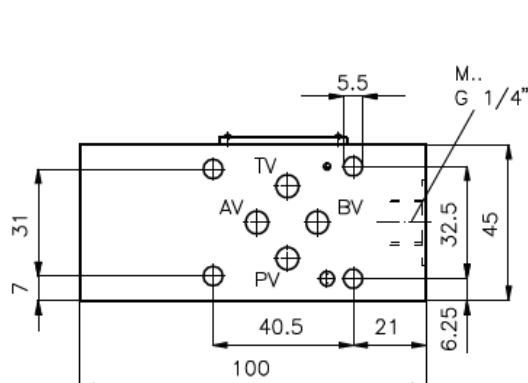

Aufnahmebohrung
C-10-2
siehe Massblatt-Nr.:
IK-100-109

Mehrzweckventilgehäuse ohne Messanschluss

Typ	a	b
MGZ-06.-PM2/PV1/10-B-04	21,5	22,5
MGZ-06.-TM1/TV2/10-B-04	21,5	22,5
MGZ-06.-AA/10-04	17,5	25
MGZ-06.-BB/10-04	17,5	25
MGZ-06.-A1/P2/10-04	17	22,5
MGZ-06.-A1/T2/10-04	17	22,5
MGZ-06.-A2/P1/10-04	17,5	20
MGZ-06.-A2/T1/10-04	17,5	20
MGZ-06.-B1/P2/10-04	17	22,5
MGZ-06.-B1/T2/10-04	17	22,5
MGZ-06.-B2/P1/10-04	17,5	20
MGZ-06.-B2/T1/10-04	17,5	20
MGZ-06.-A1/B2/10-04	19,5	24

Mehrzweckventilgehäuse mit Messanschluss

Typ	a	b
MGZ-06.-PM1/PV2/10+MPA-04	17	22,5
MGZ-06.-PM1/PV2/10+MPB-04	17	22,5
MGZ-06.-TM2/TV1/10+MTA-04	17	22,5
MGZ-06.-TM2/TV1/10+MTB-04	17	22,5
MGZ-06.-P1/T2/10+MPA-04	17	22,5
MGZ-06.-P2/T1/10+MTA-04	17	22,5
MGZ-06.-P2/T1/10+MPB-04	17	22,5
MGZ-06.-P1/T2/10+MTB-04	17	22,5

Mehrzweckventilgehäuse mit Messanschluss

MGZ-06.-PM1/PV2/10+MPA-04

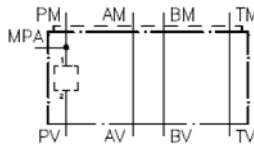

MGZ-06.-PM1/PV2/10+MPB-04

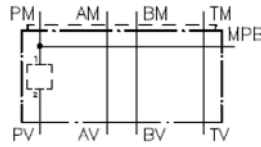

MGZ-06.-TM2/TV1/10+MTA-04

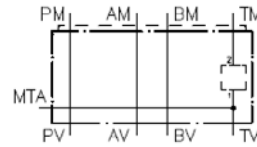

MGZ-06.-TM2/TV1/10+MTB-04

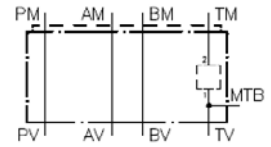

MGZ-06.-P1/T2/10+MPA-04

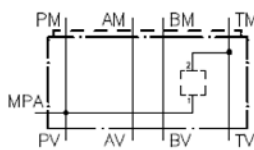

MGZ-06.-P2/T1/10+MTA-04

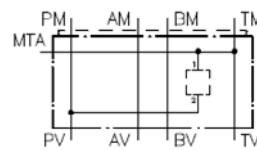

MGZ-06.-P2/T1/10+MPB-04

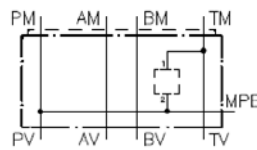

MGZ-06.-P1/T2/10+MTB-04

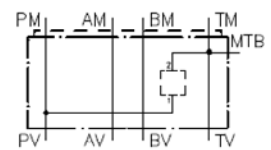

Mehrzweckventilgehäuse ohne Messanschluss

MGZ-06.-PM2/PV1/10-B-04

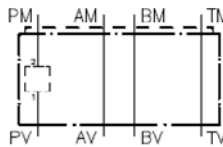

MGZ-06.-TM1/TV2/10-B-04

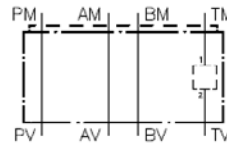

MGZ-06.-AA/10-04

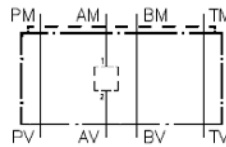

MGZ-06.-BB/10-04

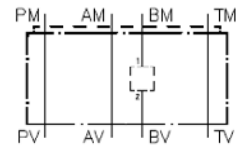

MGZ-06.-A1/P2/10-04

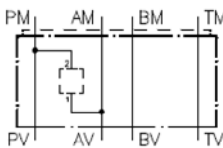

MGZ-06.-A1/T2/10-04

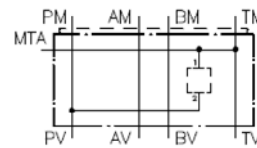

MGZ-06.-A2/P1/10-04

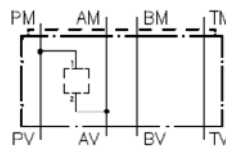

MGZ-06.-A2/T1/10-04

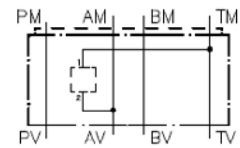

MGZ-06.-B1/P2/10-04

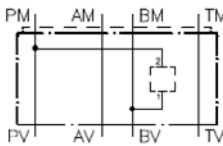

MGZ-06.-B1/T2/10-04

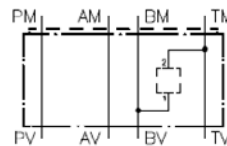

MGZ-06.-B2/P1/10-04

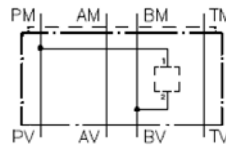

MGZ-06.-B2/T1/10-04

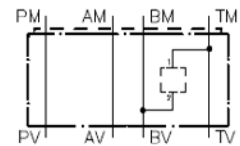

MGZ-06.-A1/B2/10-04

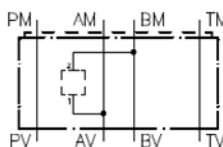

Mehrzweckventilgehäuse mit Messanschluss

Bestell-Schlüssel:

Bestell-Beispiel:

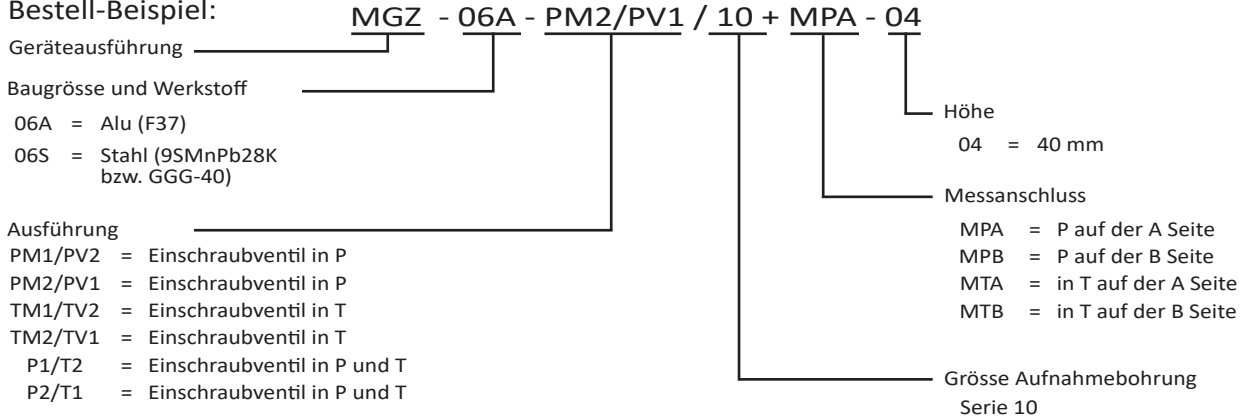

Mehrzweckventilgehäuse ohne Messanschluss

Bestell-Schlüssel:

Bestell-Beispiel:

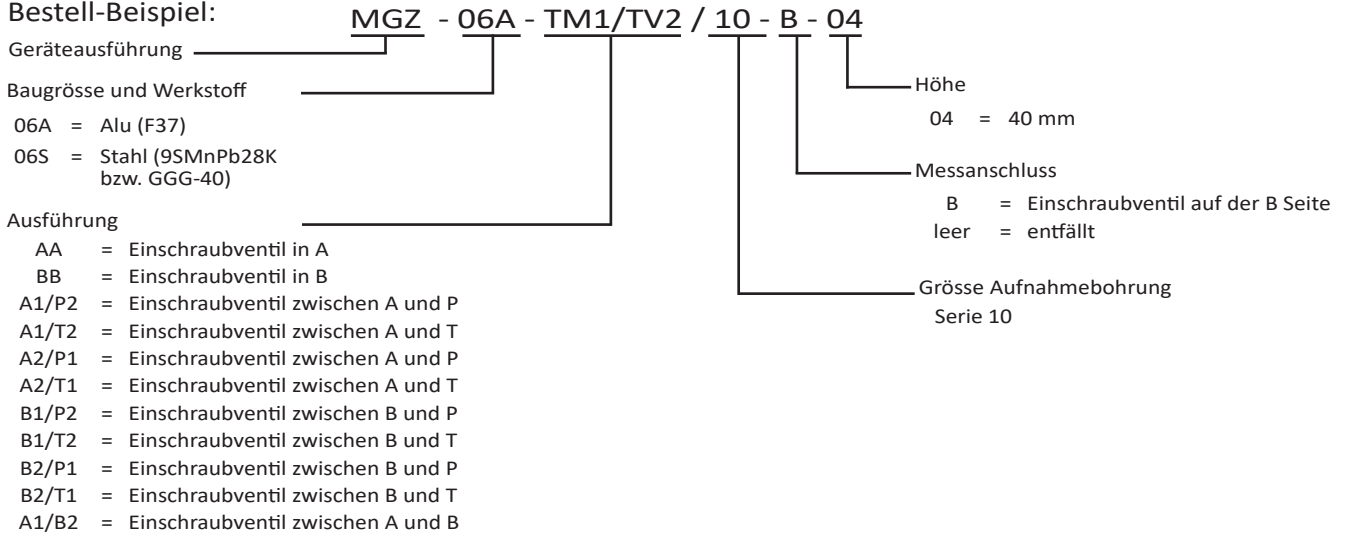

Hinweis:

Bezuglich der Durchflussrichtung ist auf die Darstellung (Anschlusse "1" und "2") zu achten. Fuer die Ausfuehrungen AA und BB aendert sich durch Drehen des Mehrzweckventilgehäuses NG 6 um die Laengsachse die Durchflussrichtung: z.B. von 1 nach 2 in 2 nach 1 oder umgekehrt (siehe Symboldarstellung). Fuer alle Ventilplatten NG 6 mit Funktion in P bzw. in T aendert sich durch Drehen um die Laengsachse zusaetzlich der Kanal: d.h. P wird T und T wird P