

Adapter-Platte von NG 16 nach NG 10 (Zwischenplatte) NG 10-XY extern

AP-16./10.-XY-S

Gewicht: ca. 2.7 kg

Nenndruck: 350 bar

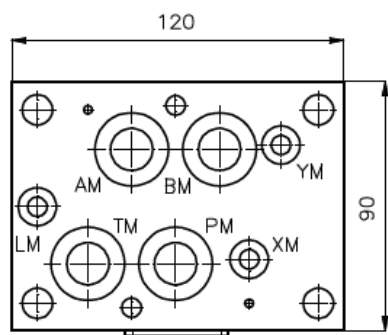
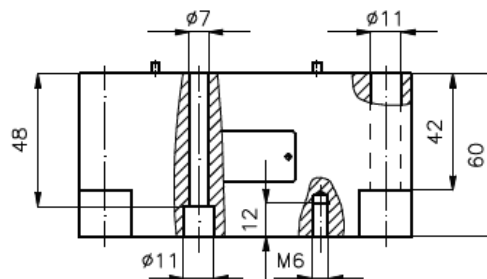
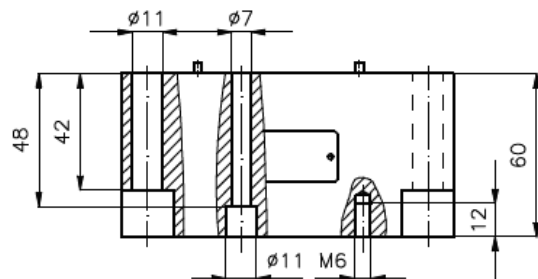
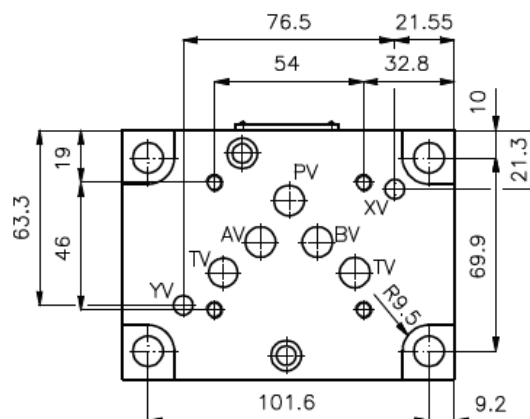
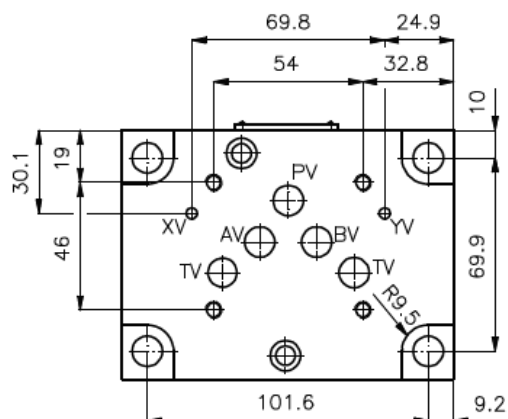

AP-16S/10S-XY

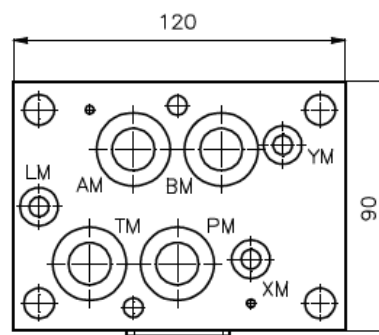

AP-16S/10S-XY-S

Symbol:

AP-16S/10S-XY
AP-16S/10S-XY-S

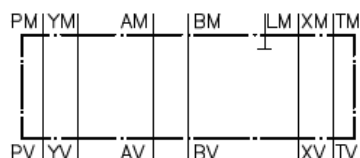

Zum Lieferumfang gehoeren:

- 4 Stck. O-Ring 22.22 x 2.62
- 3 Stck. O-Ring 9.19 x 2.62