

Adapter-Platte von NG 10 nach NG 6 (Zwischenplatte) für 4-Wege-Ventil

APR-10./06.

Gewicht: ca. 0.7 kg (A)
bzw. ca. 1.8 kg (S)

Nenndruck: 250 bar (A)
350 bar (S)

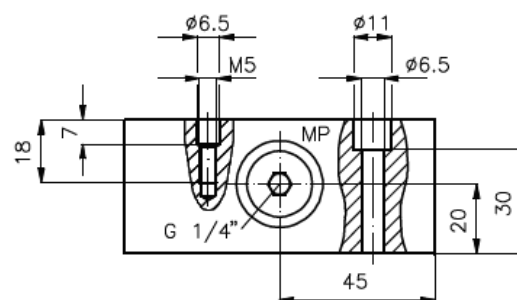
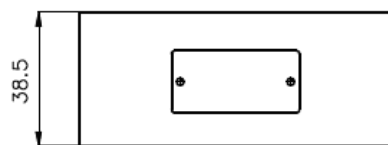
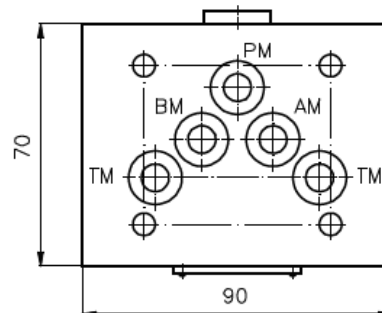
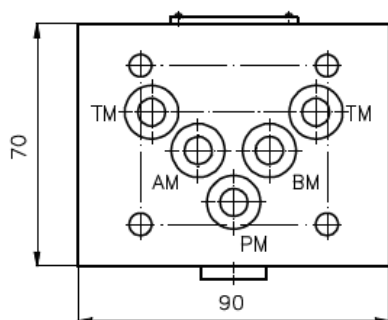
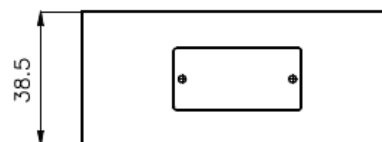
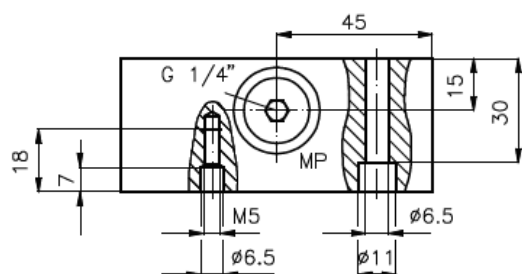
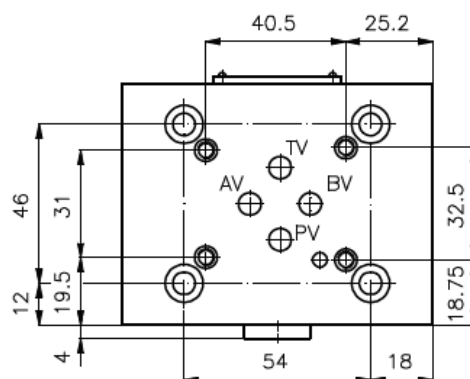
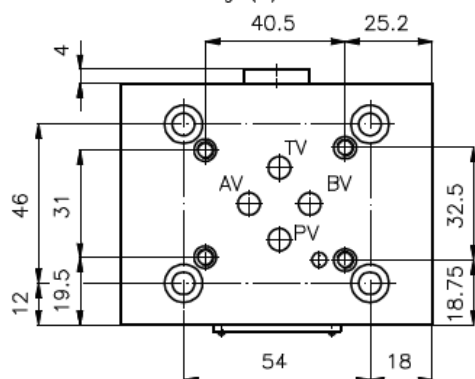

Symbol: APR-10A/06A (Alu)
APR-10S/06S (Stahl)

AP-10A/06A (Alu)
AP-10S/06S (Stahl)

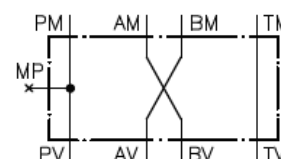
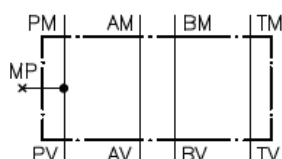

Zum Lieferumfang gehören: 5 Stck. O-Ring 12.42 x 1.78