

linking/crossover plate CETOP 3 (P, A and B connected, T closed)

UP-06.-PAB

IZ-850-204-00

(subject to change)

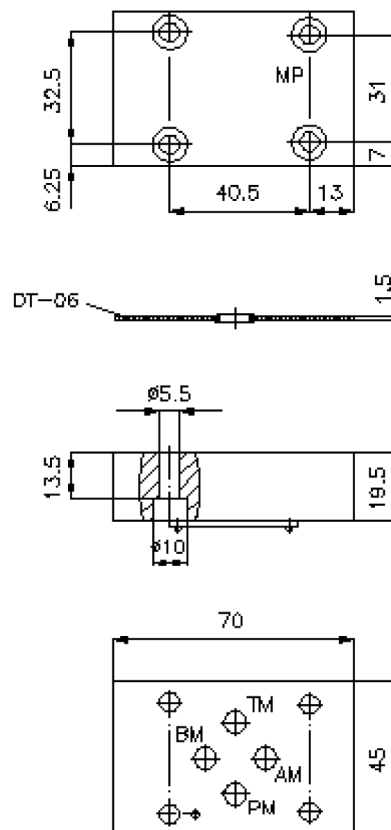
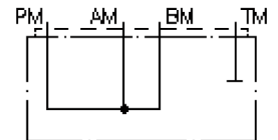

linking/crossover plate CETOP 3 (P, A and B connected, T closed)

UP-06.-PAB



Motrac Hydraulik GmbH
Siemensring 87 - D-47877 Willich
fon +49-(0)2154-8162.0 - fax +49-(0)2154-8162.499
e-mail info.miw@motracindustries.com
internet www.motracindustries.com

IZ-850-204-00

(subject to change)



Ordering example:

UP - 06A - PAB
| | |
A **B** **C**

Model code:

- A design**
turn round plate
with mounting interface DIN 24340 form A
- B size and material**
06A = aluminum (F37)
06S = steel (9SMnPb28K resp. GGG-40)
- C function mode**
PAB = P with A and B connected

Technical Data:

- note:** required mounting screws:
4 pcs. M5 x 25 DIN 912
- nominal pressure:** 250 bar (A)
350 bar (S)
- weight:** 0.2 / 0.5 kg (A/S)
- included:** DT-06 = sealing plate with vulcanized O-ring (Viton FPM)